

Subject: **Replacing the elastic fairing tape at the control surface gaps of vertical & horizontal tail, aileron, flaps and at the gaps of the engine bay doors.**

Position of the turbulators on wing, horizontal and vertical tail and wing-lets.

Affected: ASH 31 Mi - all production series

Reason: All ASH 31 Mi are fitted as standard with an elastic fairing tape at the control surface gaps and at the gaps of the engine bay doors. The gaps at the aileron, flap and at the elevator are sealed in addition by means of a Teflon sealing/slip tape.

For the removal of control surfaces, e.g. for any maintenance or repair work, it is necessary to remove the relevant elastic fairing tape on the control surface hinges side.

Action: If the elastic fairing tape needs to be removed only for maintenance or repair purposes, please observe the following:

For the purpose of disassembly of flap or aileron:

The elastic fairing tape and the sealing/slip tape need to be removed only on the lower surface (where the control surface hinges are located).

For the purpose of disassembly of elevator:

The elastic fairing tape seal and the sealing/slip tape need to be removed only on the upper surface (where the control surface hinges are located).

Disassembly of the rudder:

It is not necessary to remove the elastic fairing tape at the fin.

Disassembly of the engine bay doors:

It is not necessary to remove the elastic fairing tape.

1. Carefully remove the old elastic fairing tape in order to avoid any delaminations of the layers in this area. Remove any adhesive residue from the recessed step by means of synthetic resin thinners. With careful handling a Rubber Eraser Pad can be very helpful.
2. Accomplish any required inspection, maintenance or repair work at the control surfaces themselves and / or their hinges.
3. Cut the new elastic fairing tape and the sealing/slip tape into appropriate lengths (refer to the table under point "Material").

Note: All surfaces must be completely clean, dry and free from dust and grease!

For cleaning of the glue areas Acetone (min. 99%) proved to be best. Then sand down protruding fibres, which have been pulled out of the laminate when the old tapes were removed. Use 220-grid sandpaper. On the wing, where the step (painted white) was not milled, but already created from the mould, do not sand, but only clean!

To test the surface to be clean, stick a transparent tape strip to the surface and then pull it off again. Check that no further dust particles adhere to it.

Wing lower surface and horizontal tail upper surface:

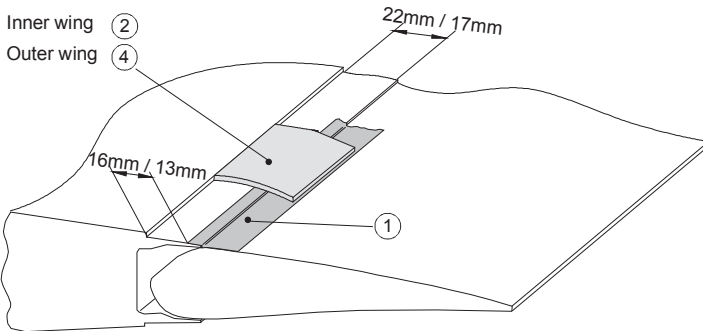

Fig. 1 (Wing lower surface)

Apply the sealing/slip tape [1] with a clearance of 16 mm (inner wing and horizontal tail) resp. 13 mm (outer wing) to the front edge of the recessed step. Be careful that the sealing/slip tape lies slack over the gap and that flap and aileron are set to maximum negative deflection (whereas the elevator must be set to maximum positive deflection) so that later the Teflon sealing/slip tape is not stretched during normal full control deflections, so as to prevent full deflections.

Apply full deflections several times so that the sealing/slip tape [1] fits well into the gap; it must be firmly rubbed down on to the surface!

Then peel the protective backing from the elastic fairing tape, and firmly stick the fairing tape into the recessed step of the wing lower surface resp. stabilizer upper surface, leaving no gap at the front edge. Use fairing tape 38/15 [2] & [8] for the inner wings lower surface resp. stabilizer upper surface and the elastic fairing tape 30/12 [4] for the outer wings lower surface. The fairing tapes for the wings are scarfed on their trailing edges.

Finally, press the adhesive zones of the elastic fairing tape [2], [4] and [8] firmly down on the surface by means of a soft wooden block (e.g: Balsa) or a hard rubber roller!

For the **horizontal tail** in addition, a protective adhesive tape [9] is applied over the joint of the front edge of the elastic fairing tape [8] and the step in the stabilizer (see Fig. 2). This tape should be as thin and moisture proof as possible; an example of a suitable tape would be white Tesa film No. 104, 38 mm wide. This protective tape serves to prevent the detachment of the front edge of the elastic fairing tape which might result in dangerous flight characteristics.

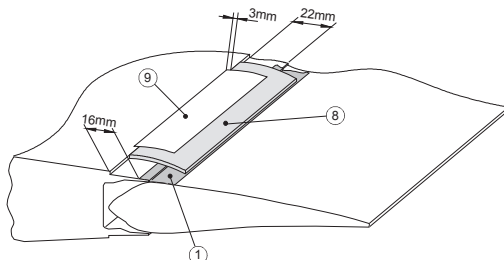

Fig. 2 (Horizontal tail upper surface)

No protective adhesive tape [9] is required on the **wing**.

Particular notes for the wing:

Particulars notes for the junction of elastic fairing tapes on the control surfaces at the wing and at the both NACA inlets on the outside of the wing:

At the junction between aileron and flap, the fairing tape must be cut in up to the wing (Fig 3).

In case of need: at the ailerons, notches parallel to the inner contour of the NACA inlets must be cut into the fairing tape and into the sealing tape, when the flap is in its most positive setting (Fig 4).

Fig. 3:

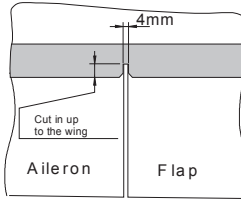
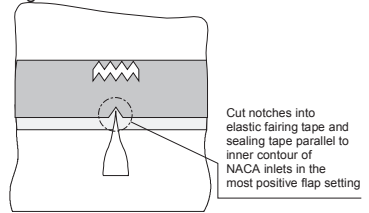

Fig. 4:



At the actuator of the aileron and the flap, a zig-zag-tape [10] (90 mm wide) is stuck. The trailing edge of the zig-zag-tape is flush with the blow holes (Fig. 5).

In front of each NACA inlet, two zig-zag-tapes [10] (any with 4 spikes), one stuck on the other, are stuck at the leading edge of the elastic fairing tape (Fig. 6).

Only at the outer wings:

In the section of the blow holes at all hinges a zig-zag-tape [10] (100 mm wide) is stuck. The trailing edge of the zig-zag-tape is flush with the blow holes (Fig. 7). The blow holes should not be closed.

In the outer section of the outer wings, instead blow holes a zig-zag-tape [10] is stuck at the trailing edge of the elastic fairing tape (Fig. 8).

21m outer wing: 1570 mm from the root rip to the outside.

18m outer wing: 1010 mm from the root rip to the outside.

Fig. 5:

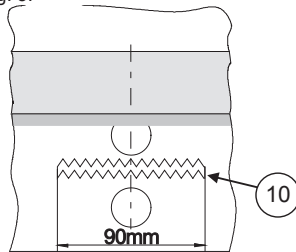

Fig. 6:

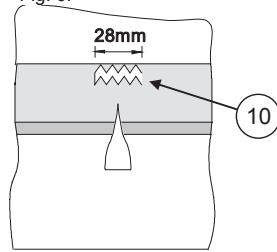

Fig. 7:

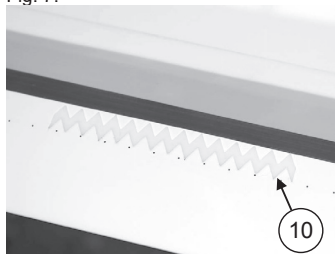
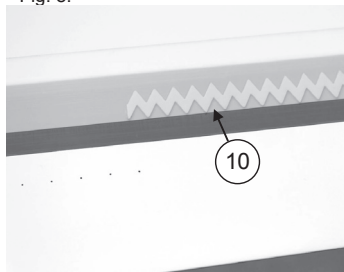

Fig. 8:



Wing upper surface and horizontal tail lower surface:

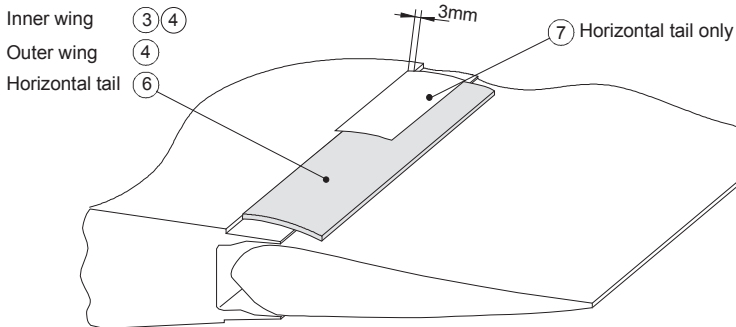

Fig. 9 (Wing upper surface and horizontal tail lower surface)

Remove the backing from the elastic fairing tape, and firmly stick the fairing tape into the recessed step of the wing upper surface resp. stabilizer lower surface, leaving no gap at the front edge. For the inner wings upper surface use fairing tape 25/12 [3] until the end of the flap, in the area of the aileron use fairing tape 30/12 [4]. Also use fairing tape 30/12 [4] for the outer wings upper surface, and fairing tape 22/15 [6] for the horizontal tail lower surface. The fairing tapes for the wings are scarfed on their trailing edges.

Finally, press the adhesive zones of the elastic fairing tapes [3], [4] and [6] firmly down on the surface by means of a soft wooden block (e.g: Balsa) or a hard rubber roller!

Only for the stabilizer in addition, a protective adhesive tape [7] is applied over the joint of the front edge of the elastic fairing tape [6] and the recessed step in the stabilizer.

Vertical Tail:

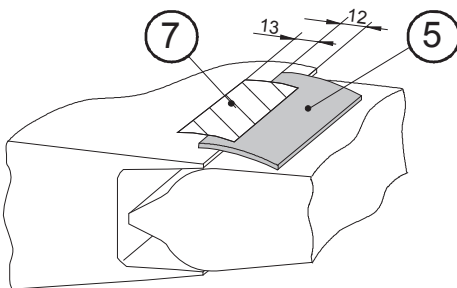

Fig. 10

There are no recessed steps at the fin. As shown in Fig. 10 the elastic fairing tape 30/12 [5] is stuck on over the rudder-fin transition at the left and right side, then pressed firmly down on the surface, and secured against detachment by sticking on a protective adhesive tape [7] (25 mm wide) over the joint of the front edge of the elastic fairing tape.

Note:

In the description it is assumed that the adhesive film is located on the elastic fairing tape. But it is also possible that the elastic fairing tape and the adhesive film are delivered as separate items. In this case the adhesive film is first applied to the wing. After peeling off the protective foil, the elastic fairing tape is affixed.

Material:

Side	Inner wing		Outer wing		Horizontal tail		Vertical tail
	upper	lower	upper	lower	upper	lower	both
[1] Sealing/slip tape, Teflon tape, 30 mm wide		2x 6,7 m		21m: 2x 3,45 m 18m: 2x 2,0 m	1x 2,7 m		
[2] elastic fairing tape 38/15*, scarfed		2x 6,7 m					
[3] elastic fairing tape 25/12*, scarfed	2x 4,5 m until the end of the flap						
[4] elastic fairing tape 30/12*, scarfed	2x 2,3 m at the aileron		21m: 2x 3,45 m 18m: 2x 2,0 m	21m: 2x 3,45 m 18m: 2x 2,0 m			
[5] elastic fairing tape 30/12*							2x 1,2 m
[6] elastic fairing tape 22/15*						2x 1,3 m	
[7] Protective adhesive tape, Tesafilm No. 104, white, 25 mm						2x 1,3 m	2x 1,2 m
[8] elastic fairing tape 38/15*					1x 2,7 m		
[9] Protective adhesive tape, Tesafilm No. 104, white, 38 mm					1x 2,7 m		

* The elastic fairing tapes are described with their width and with the width of the adhesive film attached to it (e.g. 38mm / 15mm). But it is also possible that the elastic fairing tape and the adhesive film are delivered as separate items.

Zig-Zag-Tapes:

		wing	Horizontal tail upper surface	Horizontal tail lower surface	Vertical tail left / right	Winglet	in front of NACA inlets
[10]	Zig-zag-tape thickness = 0,5 mm 12 mm wide	Inner wing 2 x 0,4 m 18m-outer wing: 2 x 1,2 m 21m-outer wing: 2 x 2,4 m	1 x 2,80 m	2 x 1,35 m	2 x 1,20 m		0,6 m
[12]	Sticker Ø20 for protection on the ends of the zig-zag-tape		2 St.	4 St.		4 St.	

The material can be ordered from Alexander Schleicher:
Phone ++49 (0) 6658-890 oder 8929, Fax: ++49 (0) 6658-8940,
E-mail: info@alexander-schleicher.de

Engine bay doors:

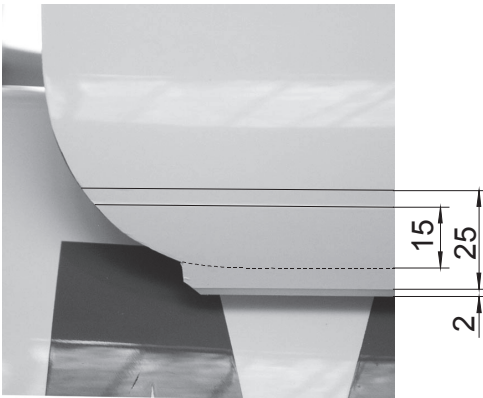

Fig. 10 Engine bay doors, rear end



Fig. 11 Engine bay doors, front end

The elastic fairing tape 22/15 [6] is adhered along the lower edge of the engine bay door with an overhang of 7 mm (only the 15 mm wide adhesive film of the elastic fairing tape is on the engine bay door). The protective adhesive tape [7] is positioned 2 mm backwards to the edge of the elastic fairing tape.

At the kink of the engine bay doors, the elastic fairing tapes will be cut to mitre. The protective adhesive tape overlaps the mitre cut about 5 mm.

The ends of the elastic fairing tapes will be cut off as shown in Fig. 10 and 11

		Engine bay doors left and right
[6]	elastic fairing tape 22/15*	2 x 1,80 m
[7]	Protective adhesive tape Tesafilm No. 104, white, 25 mm	2 x 1,80 m

Position of the zig-zag-tapes:

Winglet, inner side:

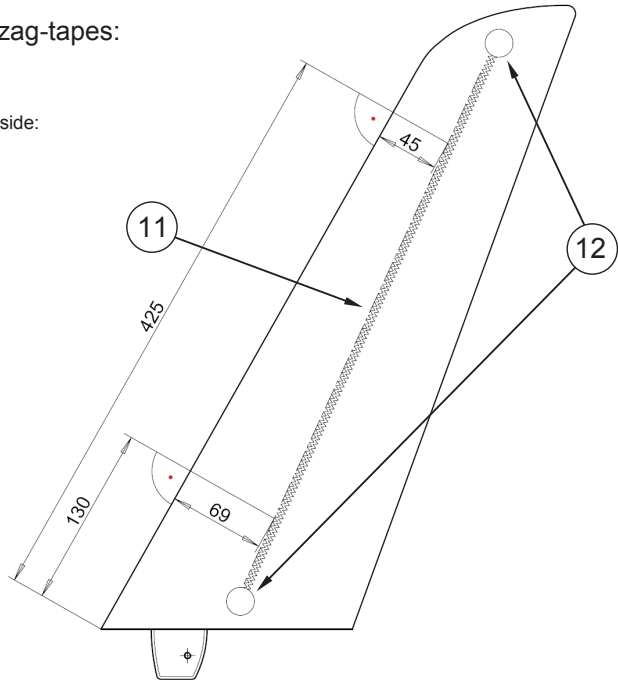

Winglet morphing section:

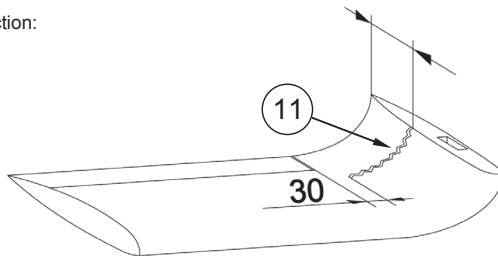

Horizontal tail, upper surface:

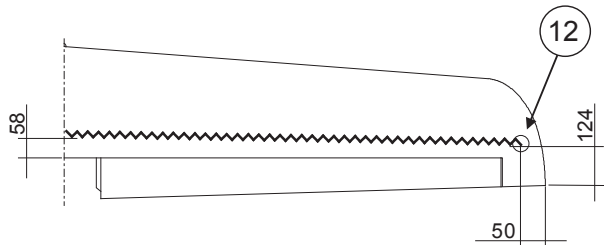

Horizontal tail, lower surface:

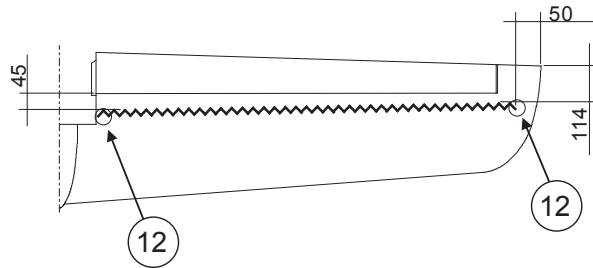

Vertical tail:

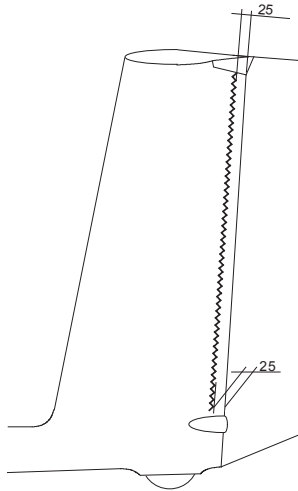

Poppenhausen, March 16, 2015 (Issue II)

Alexander Schleicher
GmbH & Co.

by order 

(M. Münch)